

UltraDuty II Rubber Flooring
TECHNICAL MANUAL
Installation • Maintenance



P.O. Box 70 Bradenton, Florida 34207

Toll Free 877-GND-ZERO (463-1376), Direct Phone 941-751-7581 Fax 1-941-751-7586

Email sales@gndzero.com

<http://www.gndzero.com>

INSTALLATION

I. JOB SITE CONDITIONS

- A. Installation should not begin until after all other trades are finished in the area. If the job requires other trades to work in the area after the installation of the floor, the flooring should be protected with an appropriate cover.
- B. Areas to receive flooring should be weather tight and maintained at a minimum uniform temperature of 65° F (18° C) for 48 hours prior to, during and after installation.

II. SUBFLOORS

Ultra Duty II, rolls and tiles, may be installed over concrete, approved cementitious based self-leveling materials such as Ardex K-15 or equivalent, and wood.

Note: Gypsum based patching and leveling compounds are not acceptable.

- A. Wood Subfloors: Wood subfloors should be double construction with a minimum thickness of 1". The floor must be rigid, free from movement and have at least 18" of well-ventilated air space below.
- B. Underlayments: The preferred underlayment panel is APA underlayment grade plywood, minimum thickness of 1/4", with a fully sanded face.

Note: Particle board, chip board, Masonite, and lauan are not considered suitable underlayments.

- C. Concrete Floors: Concrete shall have a minimum compressive strength of 3000 psi. It must be fully cured and permanently dry.

III. SUBFLOOR REQUIREMENTS AND PREPARATION

- A. Subfloor shall be dry, clean, smooth, level, and structurally sound. They should be free of dust, solvent, paint, wax, oil, grease, asphalt, sealers, curing and hardening compounds, alkaline salts, old adhesive residue and other extraneous materials, according to ASTM F710.
- B. Subfloor should be smooth to prevent irregularities, roughness, or other defects from telegraphing through the new flooring. The surface should be flat to the equivalent of 3/16" (4.8 mm) in 10 feet (3.0 m).
- C. Mechanically remove all traces of old adhesives, paint or other debris by scraping, sanding or scarifying the substrate. Do not use solvents. All high spots shall be ground level and low spots filled with an approved cementitious based patching compound.
- D. All saw cuts (control joints), cracks, indentations and other non-moving joints in the concrete must be filled with an approved cementitious based patching compound.
- E. Expansion joints in the concrete are designed to allow for expansion and contraction of the concrete. If a floor covering is installed over an expansion joint, it more than likely will fail in that area. Expansion joint covers designed for resilient floor coverings should be used.



P.O. Box 70 Bradenton, Florida 34207

Toll Free 877-GND-ZERO (463-1376), Direct Phone 941-751-7581 Fax 1-941-751-7586

Email sales@gndzero.com

<http://www.gndzero.com>

- F. Always allow patching materials to dry thoroughly and install according to the manufacturer's instructions. Excessive moisture in patching material may cause bonding problems or a bubbling reaction with the GZ C-2000~ adhesive.

HAZARDS:

SILICA WARNING - Concrete, floor patching compounds, toppings and leveling compounds can contain free crystalline silica. Respirable crystalline silica (particles 1-10 micrometers) can be produced by cutting, sawing, grinding or drilling. Respirable silica is classified by OSHA as a IA carcinogen and is known to cause silicosis and other respiratory diseases. Avoid actions that cause dust to become airborne. Use local or general ventilation, or protective equipment, to reduce exposure below applicable exposure limits.

ASBESTOS WARNING - Resilient flooring, backing, lining felt, paint or asphaltic "cutback" adhesives can contain asbestos fibers. Avoid actions that cause dust to become airborne. Do not sand, dry sweep, dry scrape, drill, saw, beadblast or mechanically chip or pulverize. Regulations may require that the material be tested to determine *asbestos content*. Consult the documents titled, *Recommended Work Practices for Removal of Existing Resilient Floor Coverings*, available from the Resilient Floor Covering Institute.

LEAD WARNING - Certain paints can contain lead. Exposure to excessive amounts of lead dust presents a health hazard. Refer to applicable federal, state and local laws and the publication, *Lead Based Paint: Guidelines for Hazard Identification and Abatement in Public and Indian Housing*, available from the United States Department of Housing and Urban Development.

- G. Maximum moisture vapor emission of the concrete must not exceed 5.5 lbs. per 1000 sq/ft in a 24 hour period as measured by the calcium chloride moisture emission test conducted in accordance to ASTM

F1869. If the emissions exceed the limitations, the installation should not proceed until the problem has been corrected.

- H. It is essential that pH tests be taken on all concrete floors. If the pH is greater than 9, it must be neutralized prior to beginning the installation.
- I. Adhesive bond tests should be conducted in several locations throughout the area. Glue down 3' x 3' pieces of the flooring with the recommended adhesive and trowel. Allow to set for 72 hours before attempting to remove. A sufficient amount of force should be required to remove the flooring, and there should be adhesive on the subfloor and the back of the flooring.

IV. MATERIAL STORAGE AND HANDLING

Rolls and Tiles

- A. Material should be delivered to the job site in its original unopened packaging with all labels intact.
- B. Inspect all material for visual defects prior to beginning the installation. No labor claim will be honored on material installed with visual defects. Verify the material delivered is the correct style, color and amount. Any discrepancies must be reported immediately before beginning installation.
- C. The material and adhesive must be climatized at room temperature for a minimum of 24 hours before starting installation.
- D. All Ultra Duty II rolls must be unrolled and installed in the same direction, (directional arrows are stamped on bottom of the rolls). Ultra Duty II tiles must also be installed in the same direction (arrows on the bottom must be pointing in the same direction). Rolls are labeled with batch numbers and



P.O. Box 70 Bradenton, Florida 34207

Toll Free 877-GND-ZERO (463-1376), Direct Phone 941-751-7581 Fax 1-941-751-7586

Email sales@gndzero.com

<http://www.gndzero.com>

roll numbers. Do not mix batch numbers together and install all rolls in consecutive order. See diagram .1

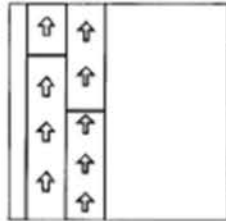

Diagram 1

- E. Roll material is stretched slightly when it is rolled at the factory. At the job site the installer should allow all cuts to relax for a minimum of two hours before gluing down.

V. INSTALLATION - ROLLS

- A. Cut the first sheet at the required length including enough to run up the wall and overlap for seaming at each end.
- B. Position the first sheet against the wall and square with the room.
- C. Cut second sheet with proper extra length.
- D. Position second sheet with a 1"-1.5" overlap over the first roll at the seam.

- E. Repeat for each consecutive sheet necessary to complete the area or those rolls that will be installed that day.
- F. Allow the cuts to relax in position for a minimum of 2 hours before gluing.

G. SEAMING METHODS

1. (4 mm & 6mm thick material) Place a 4" wide scrap of material under the seam area. Using a straight edge and new razor blade, hold the knife straight up

and down and cut through both pieces in one cut. (See diagram 2).

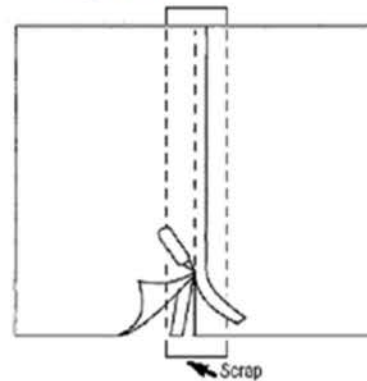

Diagram 2

2. (9mm thick material) Snap a chalk line where the seam will be located. Straight edge seam edge of first piece. Align the first edge to the chalk line; it is very important that the seam is perfectly straight. Straight edge seam edge of second drop and butt to first edge. Do not try to compress or stretch the material.



Diagram 3

- H. After all above procedures are performed, begin application of GZ C-2000, Ground Zero's recommended one-component polyurethane adhesive. Apply GZ C-2000 to the substrate using a 1/16" square notched trowel. Use a new trowel for each pail of adhesive or more frequently if trowel begins to wear down, do not re-notch the trowel.

- I. Fold the first drop lengthwise (half the width of the roll).



P.O. Box 70 Bradenton, Florida 34207

Toll Free 877-GND-ZERO (463-1376), Direct Phone 941-751-7581 Fax 1-941-751-7586

Email sales@gndzero.com

http://www.gndzero.com

- J. Spread adhesive using proper notch trowel. Take care not to spread more GZ C-2000 than can be covered by flooring and rolled within 30 minutes. The open time of the adhesive is 30 - 40 minutes at 70°F and 50% relative humidity.

Note: The open time of adhesive is affected by temperature and humidity. High temperatures and high humidity will cause the adhesive to set up quickly. Low temperatures and low humidity will cause adhesive to cure at a slower rate. The installer should monitor on-site conditions and adjust open time accordingly.

- K. Carefully lay the material into the wet adhesive. DO NOT let the material drop because this will cause air to be trapped beneath the flooring.
- L. Immediately roll the floor with a 100 lb roller to ensure proper transfer of adhesive. Overlap each pass of the roller by 50% of the previous pass to ensure that the floor is properly rolled. Roll the width first then the length. Re-roll again after 30-45 minutes.
- M. Fold over second half of first roll and half of second sheet. Spread adhesive. At seam area spread adhesive at 90 degrees to seam to eliminate excessive adhesive oozing up at seam. Roll material.
- N. With 4mm thick material it may be necessary to weight down the seam until the adhesive sets. Boxes of cove base work well. Cover the entire seam.
- O. Continue the process for each consecutive drop. Always work at a pace so that you are always folding material back into wet adhesive.

Note: Never leave adhesive ridges or puddles, they will telegraph through the material.

- P. Do not allow GZ C-2000 to cure on your hands or the flooring. Immediately wipe off excess adhesive with a rag dampened with mineral spirits! Cured adhesive is very difficult to remove. **We strongly suggest wearing gloves when using GZ C-2000!**
- Q. Hand roll all seams after the entire floor has been rolled. If some seams are gapping, hold them together temporarily with masking tape. Do not use duct tape as it may leave a residue on the floor. Remove tape after adhesive has developed a firm set.
- R. After you rolled the floor, keep all foot traffic off the floor for a minimum of 24 hours. Foot traffic and rolling loads can cause permanent indentations or bubbles in the uncured adhesive.

VI. INSTALLATION - TILES

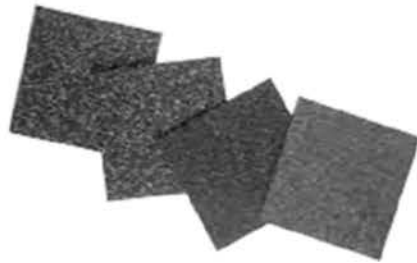

- A. General: Make sure all material is from the same batch number. Mix tiles from several boxes or skids. Ensure that moisture, pH, and bond tests have been conducted with passing results. Ensure that jobsite and subfloor conditions are met.
- B. Measure the width of the area to be covered.
- C. Mark the center of the area at two points, one at each end.
- D. Snap the chalk line, line #1, through these two points.



P.O. Box 70 Bradenton, Florida 34207

Toll Free 877-GND-ZERO (463-1376), Direct Phone 941-751-7581 Fax 1-941-751-7586

Email sales@gndzero.com

<http://www.gndzero.com>

- E. Determine the center point of the chalk line.
- F. Using a Carpenter's square or another method, snap a second chalk line, line #2, perpendicular (at 90 degrees) to the first line. The lines should intersect at their centers.
- G. The area to be covered is now divided into quarters. Begin the installation at the center of the area, where the two lines intersect.

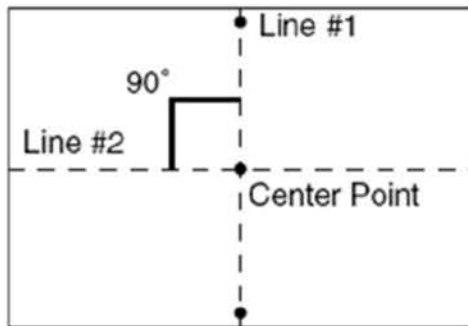

Diagram 5a

Note: To lay tiles in an ashlar configuration, snap a third chalk line perpendicular to line #2 and parallel to line #1. The distance between line #1 and line #3 should be 1/2 the width of the tile (9 or 18 inches). See diagram 6.

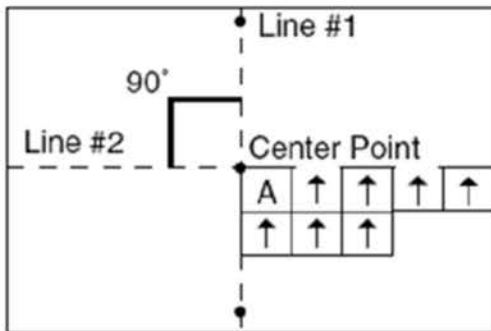

Diagram 5b

- H. After the above procedure is performed, begin application of GZ C-2000, Ground Zero's recommended one-component polyurethane adhesive. Apply GZ C-2000 to the substrate using a 1/16" square notched trowel. Use a new

trowel for each pail of adhesive or more frequently if trowel begins to wear down, do not re-notch the trowel.

- I. Take care not to spread more adhesive than can be covered by flooring and rolled within 30 minutes.
- J. Place the first tile **A** into the wet adhesive making sure that the edges are precisely placed along the chalk lines and where they intersect. Press firmly on the tiles to remove any curls or entrapped air. Do not try to stretch or compress fit the tiles. See diagram 5a and 5b above.

Reminder: Arrows on bottom of tiles must point in the same direction.

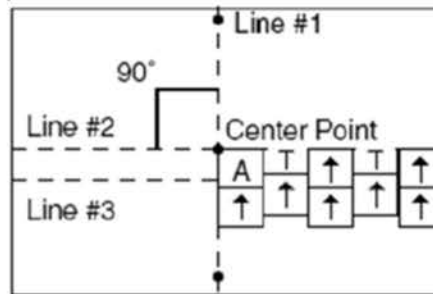

Diagram 6

- K. Lay whole tiles from left to right along chalk line #1 up to the wall on the opposite side of chalk line #2. The last tile will likely have to be cut to fit against the wall.
- L. Do not allow GZ C-2000 to cure on your hands or the flooring. Wipe off excess adhesive with a rag dampened with mineral spirits! Cured adhesive is very difficult to remove from hands. **We strongly suggest wearing gloves when using GZ C-2000!**
- M. Continue this process with each row until you reach the wall across from chalk line #1.



P.O. Box 70 Bradenton, Florida 34207

Toll Free 877-GND-ZERO (463-1376), Direct Phone 941-751-7581 Fax 1-941-751-7586

Email sales@gndzero.com

<http://www.gndzero.com>

- N. Go back and fill in gaps between the two original chalk lines and the wall on those two sides.
- O. If some seams are gapping, hold them together temporarily with masking tape. Do not use duct tape as it may leave a residue on the floor. Remove the tape after the adhesive has developed a firm set. It may be necessary to weigh down some seams.
- P. Roll a 100 lb roller over the floor within 45 minutes to ensure proper transfer of adhesive. Overlap each pass of the roller by 50% of the previous pass to ensure that the floor is properly rolled. Re-roll again after 30-45 minutes.
- Q. Keep foot traffic off the floor for a minimum of 24 hours. Foot traffic and rolling loads can cause permanent indentations in the uncured adhesive and cause tiles to shift.

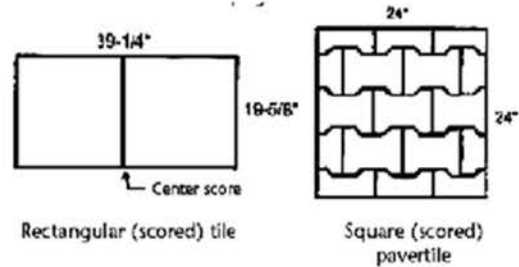

A. INDOOR INSTALLATION

1. The material and adhesive must be climatized at room temperature for a minimum of 24 hours before starting installation.
2. Lay out molded pavers/tiles before adhering to minimize cutting and waste.
3. Always begin installation with chalk lines that are perfectly square in the room. It is best to begin laying tiles away from the walls.
4. After all above procedures are performed, begin application of GZ C-2000, Ground Zero's recommended one component polyurethane adhesive. Apply E-GriplI to the substrate using a 1/8" square notched trowel. Monitor the tooth size of the trowel blade frequently, and use a new blade with each new pail of adhesive.
5. Apply GZ C-2000 evenly at a rate of approximately 95 sq/ft per gallon over smooth concrete. Various substrates may effect this coverage rate. Do not allow GZ C-2000 to cure on your hands or the flooring. Wipe off excess adhesive with a rag dampened with mineral spirits! Cured adhesive is very difficult to remove from hands. **We strongly suggest wearing gloves when using the GZ C-2000!**
6. Place the first tile into the wet adhesive making sure that the edges are precisely placed along chalk lines and where they intersect. Press firmly on the flooring to remove any curls or entrapped air.

B. LAYING TILES – INDOOR

VII. ULTRA DUTY II MOLDED TILES

Note: All Ultra Duty II products are to be installed over a solid substrate.

Split Pavers (7/8" thick) must always be adhered to the substrate.

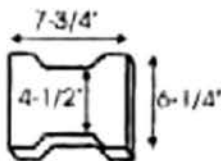

Full Pavers (1 3/4" thick) may be adhered or loose-laid. If loose-laid, pavers must be installed against a perimeter border system.



P.O. Box 70 Bradenton, Florida 34207
Toll Free 877-GND-ZERO (463-1376), **Direct Phone** 941-751-7581 **Fax** 1-941-751-7586
Email sales@gndzero.com
<http://www.gndzero.com>

1. Pavers: Interlock and shift whole pavers from left to right along chalk line #1 up to the wall on the opposite side of chalk line #2. The last paver will likely have to be cut to fit against the wall. See diagram 7.

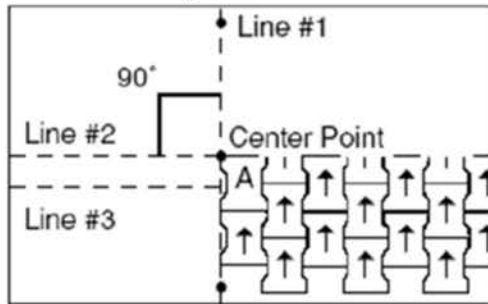

Diagram 7

2. Tiles & Pavertiles: Place the first tile into the wet adhesive making sure that the edges are precisely placed along the chalk lines and where they intersect. Press firmly on the tiles to remove any curls or entrapped air. See diagram 5a or 5b on page 6.
3. Continue this process with each row until you reach the wall across from chalk line #1.
4. Go back and fill in gaps between the two original chalk lines and the wall on those two sides.
5. Immediately roll the floor with a 150 lb. roller to ensure proper transfer of adhesive. Overlap each pass of the roller by 50% of the previous pass to ensure that the floor is properly rolled. Roll the width first then the length. Re-roll again after 30-45 minutes.
6. Keep foot traffic off the floor for a minimum of 24 hours. Foot traffic and rolling loads can cause permanent indentations

in the uncured adhesive and cause tiles to shift.

7. Allow the adhesive to cure for a minimum of 12 hours before applying any sealer to the floor.

C. OUTDOOR INSTALLATION

1. Glued down installation on concrete, asphalt and crushed stone. Base materials for Ultra Duty II are fully cured concrete or asphalt. Both are ideal for load bearing areas with heavy traffic or moving vehicles.
2. Make sure to allow for a 1.5% slope or fall for moisture movement to drainage pit.
3. Bituminous concrete mixture requirements for asphalt top layer specifications are outlined above:

Sieve Size	Opening	Millimeters	% Passing
3/8"	.375	9.53	100
#4	.187	4.75	80
#8	.0937	2.36	54
#16	.0469	1.18	32
#30	.0234	0.60	18
#50	.0117	0.300	12
#100	.0059	0.150	9
#200	.0029	0.075	6

Note: A filter fabric is necessary for crushed stone bases. Tiles are adhered to the filter fabric. This filter fabric system will allow moisture to penetrate between surface joints and to evaporate in the base. Some bases will require a plastic perforated drain pipe to remove possible moisture build-up.

4. Lay out molded pavers/tiles before adhering to minimize cutting and waste.
5. Always begin installation with chalk lines that are perfectly



square. It is best to begin laying product away from the walls.

6. After all above procedures are performed, begin application of GZ C-2000, Ground Zero's recommended one component polyurethane adhesive. Apply GZ C-2000 to the substrate using a 1/8" square notched trowel. Monitor the tooth size of the trowel blade frequently and use a new blade as needed to ensure the proper amount of adhesive is applied.
7. Apply GZ C-2000 evenly at a rate of 65 sq/ft per gallon over smooth concrete. Various substrates may effect this coverage rate. Do not allow GZ C-2000 to cure on your hands or the flooring. Wipe off excess adhesive with a rag dampened with mineral spirits! Cured adhesive is very difficult to remove from hands. **We strongly suggest wearing gloves when using the GZ C-2000!**
8. Place the molded pavers/tiles into the wet adhesive making sure that the edges are precisely placed along chalk lines where they intersect. Press firmly on the flooring to remove any curls or entrapped air.

D. LAYING TILES - OUTDOOR

1. Pavers: Interlock and shift whole pavers from left to right along chalk line #1 up to the perimeter border on the opposite side of chalk line #2. The last paver will likely have to be cut to fit against the perimeter border. See diagram 7 page 8.
2. Tiles & Pavertiles: Place the first tile into the wet adhesive making sure that the edges are precisely placed along the chalk lines and where they intersect. Press firmly on the tiles to

remove any curls or entrapped air. See diagram 5a and 5b on page 6.

3. Continue this process with each row until you reach the perimeter border across from chalk line #1.
4. Go back and fill in gaps between the two original chalk lines and the wall on those two sides.
5. Roll a 150 lb roller over the floor within 30 minutes to ensure proper transfer of adhesive. Overlap each pass of the roller by 50% of the previous pass to ensure that the floor is properly rolled. Re-roll again after 30-45 minutes.
6. Keep foot traffic off the floor for minimum of 24 hours. Foot traffic and rolling loads can cause permanent indentations in the uncured adhesive and cause tiles to shift.

E. LOOSE-LAID INSTALLATION: (FULL PAVERS ONLY)

1. BASE REQUIREMENTS

- a. Base must contain sand/crushed stone with perimeter border system.
- b. Pavers must be installed butting up against perimeter border system.

2. CRUSHED STONE SPECIFICATIONS

- a. 95% standard proctor compaction (as per ASTM D1557) is critical.
- b. Stone for the base must be crushed so it compacts to the above standard and should be a homogeneous mix of the following sizes:



P.O. Box 70 Bradenton, Florida 34207

Toll Free 877-GND-ZERO (463-1376), Direct Phone 941-751-7581 Fax 1-941-751-7586

Email sales@gndzero.com

<http://www.gndzero.com>

Sieve Size	% Passing by Weight
1"	90-100
5/8"	50-80
1/4"	30-50
#4	15-35
#8	10-30
#30	3-5
#200	0-3

- c. Minimum depth of crushed stone base should be 4".
- d. Base can be flat or sloped 2%.

- a. Excavate soil approximately 12".
- b. Replace soil with approximately 9" of compacted crushed stone and approximately 1" of damp leveling sand.
- c. Install perimeter border system.
- d. Lay pavers in desired pattern.

3. PROCEDURE

MAINTENANCE

IMPORTANT INFORMATION FOR THE SPECIFIER

Ground Zero recommends Ground Zero Maintenance Products and Procedures for Ultra Duty II.

Proper protection and maintenance of Ultra Duty II post-installation should be specified by the architect/designer. Ultra Duty II products are not pre-coated with a factory finish; therefore, they should not be subject to construction debris and potential damage caused from heavy duty construction activities.

FLOOR PROTECTION

The specifier should include specification details to protect the floor post-installation and until job construction is complete, such as covering the entire floor with paper or other floor covering device (plastic, plywood, etc.) until construction is completed and thorough cleaning and maintenance can be implemented.

ASSIGNMENT OF CLEANING AND MAINTENANCE

The specifier should determine and assign the responsibility for the initial cleaning and finishing. This responsibility should be specifically assigned to either the flooring contractor, general contractor, maintenance contractor or owner.



P.O. Box 70 Bradenton, Florida 34207
 Toll Free 877-GND-ZERO (463-1376), Direct Phone 941-751-7581 Fax 1-941-751-7586
 Email sales@gndzero.com
<http://www.gndzero.com>